

PLANTA BAIXA-TANQUE SÉPTICO

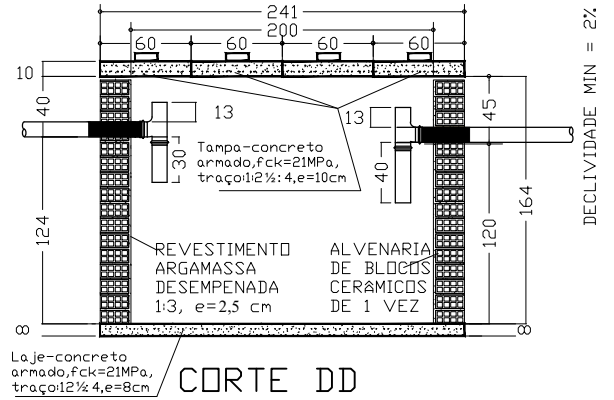

CORTE DD

Esc.: 1:50

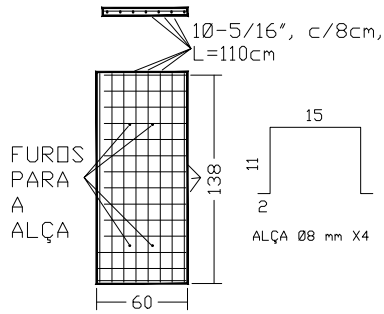

TAMPA X4

(60x140) x 4
Esc.: 1 / 50

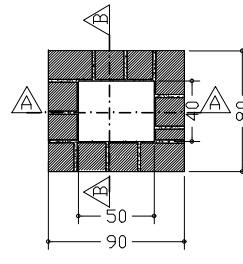

PLANTA X4

Esc.: 1:50

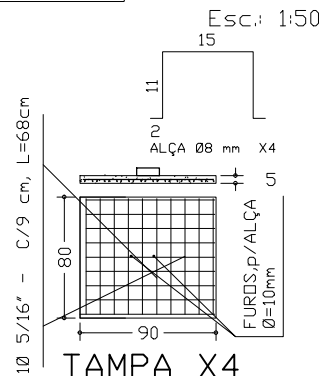

TAMPA X4

Esc.: 1:50

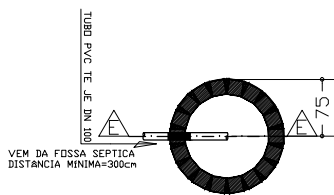
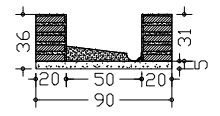
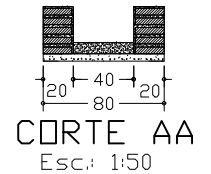

PLANTA BAIXA SUMIDOURO

Esc.: 1 / 100

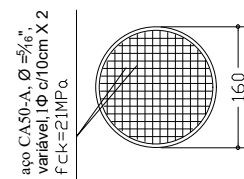

TAMPA, SUMIDOURO

Esc.: 1 / 100

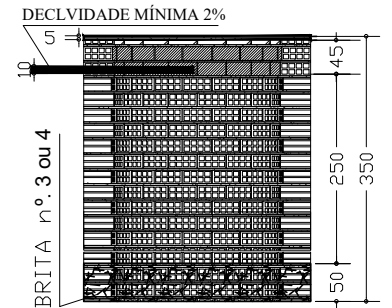

CORTE EE SUMIDOURO

Esc.: 1:100

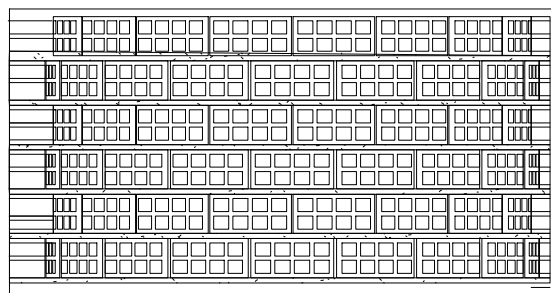

DETALHE: ALVENARIA SUMIDOURO

Esc.: 1:50

RESPONSÁVEL TÉCNICO
MATHEUS ALVES DE MEDEIROS

DIGITALIZAÇÃO
MATHEUS ALVES

PROPRIETÁRIO
PREFEITURA DE PAU DOS FERROS

OBRA
MELHORIA HABITACIONAL PARA O CONTROLE DE CHAGAS

LOCAL
PAU DOS FERROS - RN

ASSUNTO
PROJETO HIDROSSANITÁRIO
A = 53,91 m²

PRANCHA
08/11

DATA
DE ZEMBRO
2018

OBSERVAÇÕES
1. IMPRESSÃO EM FOLHA A4 PARA RESPEITAR AS ESCALAS INFORMADAS. 2. DIREITOS AUTORAIS RESERVADOS. PROIBIDA QUALQUER MODIFICAÇÃO OU REPRODUÇÃO NO TODO OU EM PARTE, SEM PRÉVIO CONSENTIMENTO DO AUTOR DO PROJETO. CLE 19.610/98

